

INSTALLATION INSTRUCTIONS

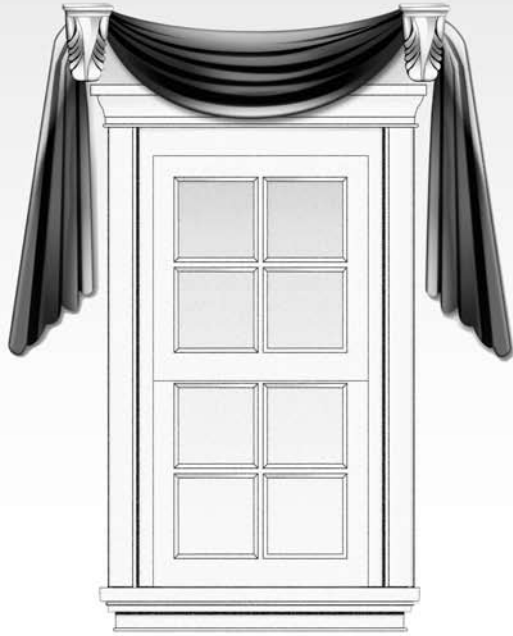
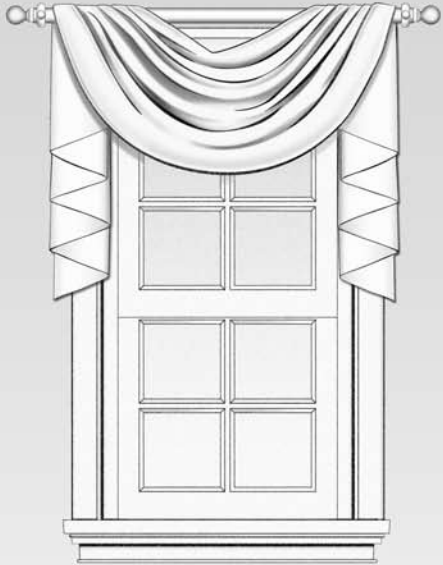

Pole Swag Valance Scarf Valance

Pole Swag Valance Scarf Valance

Installation Instructions

Thank you for purchasing your new valance. It has been custom made from the highest quality materials to the dimensions you specified. With proper installation and care, it will provide you with many years of beauty and trouble-free use.

Installing your valance is easy. Please read all applicable instructions before you start so you will be familiar with the overall process.

Tools Required:

- Power drill with the following bits:
 - 1/16" and 3/16" drill bits
 - 1/4" hex driver
 - Phillips screwdriver
 - Masonry or metal drill bits (if mounting surface requires)
- Pencil
- Awl
- Tape measure
- Level
- Ladder or stepstool

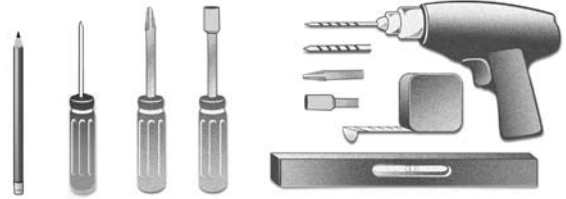

Special Fasteners

The brackets must be securely attached to the mounting surface. If wood studs are not available, use special fasteners designed for your mounting surface (not included). See illustration for examples.

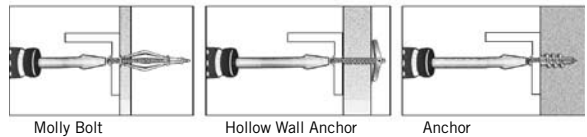

Tips

- If drilling into metal, purchase self-tapping screws.
- When selecting your fastener, make sure it is designed to support the weight of the product being installed. Follow the fastener manufacturer's instructions carefully.

Pole Swag Valance

Hardware:

- Rod
- Finials
- 2 end brackets
- Center support brackets (for wide rods only)
- Screws

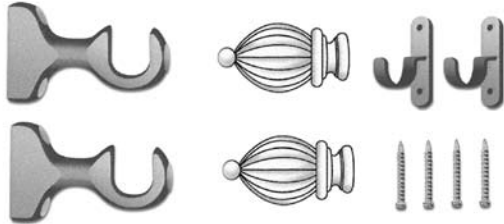

Madison Rods—Before You Begin

A. Size the Rod

The finished length of the rod should equal the area to be covered plus the thickness of the brackets (1" for each end bracket).

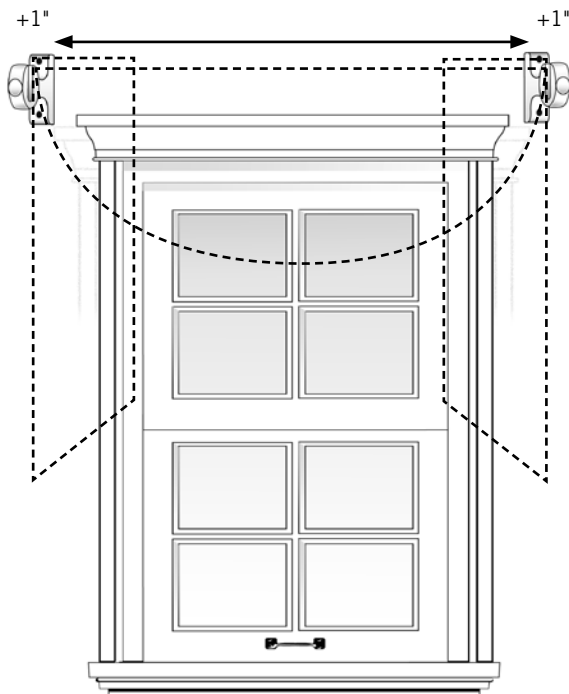

Two-Piece Rods:

Use a saw to cut each piece of the rod to half the correct finished length. Drill a $\frac{3}{16}$ " hole in the center of each of the cut ends for the finials. Join the two halves of the rod at the predrilled ends using the double-ended screw provided.



One-Piece Rods:

Use a saw to cut the rod to the correct finished length. Drill a $\frac{3}{16}$ " pilot hole in the center of the cut end (for attaching the finial).

B. Attach the Finials

Screw on the finial at each end of the rod.



Madison, Estate, or Amalfi Rods

Step 1: Attach the Brackets to the Wall

Mark the bracket locations on the wall, making sure they are level and centered over the window. Be sure the brackets are high enough so that the window will not be visible above the swags.

Mark the mounting hole positions for the brackets. For wood brackets, remove the plug covering the mounting hole and use an awl to mark the position on the wall through the hole in the bracket.

Drill $\frac{1}{16}$ " pilot holes, and attach the brackets using the screws provided. For wood brackets, replace the hole cover after setting the screw.

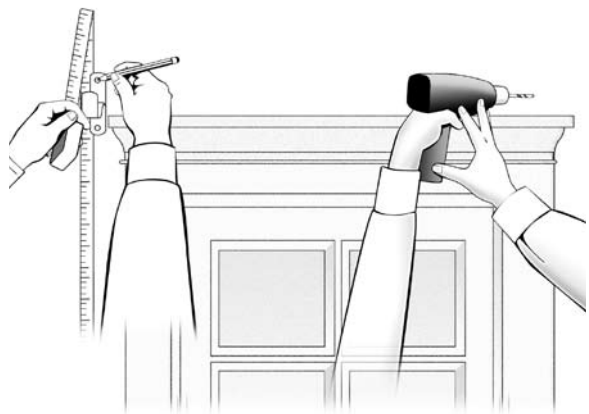

Step 2: Attach Center Supports (if needed)

If center supports are required, measure and mark the positions, making sure they will be level with the end brackets. For wood rods that are joined in the center, be sure a support is mounted at the joining point.

Drill $\frac{1}{16}$ " pilot holes, and attach the supports using the screws provided.

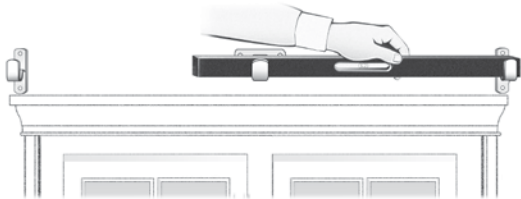

Step 3: Mount the VELCRO® Strips on the Pole

The VELCRO hook strips to be attached to the pole come attached to their corresponding loop strips on the undersides of the swags.

Single Swag or Multiple Swags

Place the pole onto the brackets and center it over the window. For adjustable rods, adjust the rod to the correct length and place a strip of masking tape at the joint to hold it in position. (Remove the masking tape after the VELCRO strips are in place.)

Mark the pole at the inside edge of each bracket and then take it down. Remove one of the VELCRO hook strips from the swag, remove the backing, and attach it to the pole beginning at the bracket-edge marking. The position of this strip is now the top of the pole. Attach the other VELCRO hook strip at the other bracket-edge marking, making sure it is aligned with the first strip.

For a single swag, continue with step 4. For multiple swags, follow the steps on the next page.

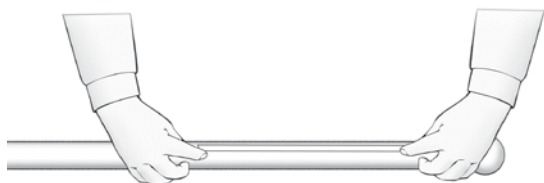
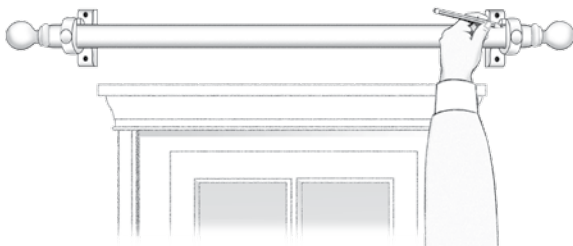

Multiple Swags

Measure the distance between the centers of the VELCRO strips already attached to the pole. Divide this number by the total number of swags. The result is the distance between centers for each additional VELCRO strip. Example: 4 swags, 120" between centers of end strips, equals 30" between centers.

Mark the center points for the remaining VELCRO strips and attach them to the top of the pole aligned with the end strips.

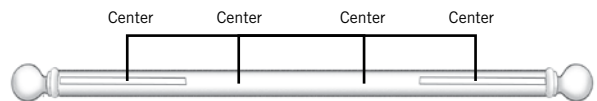

Step 4: Place the Cascades on the Pole

Fasten the chains around the pole as shown. Place the pole on the brackets and align the cascades with the outside edges of the end VELCRO strips.

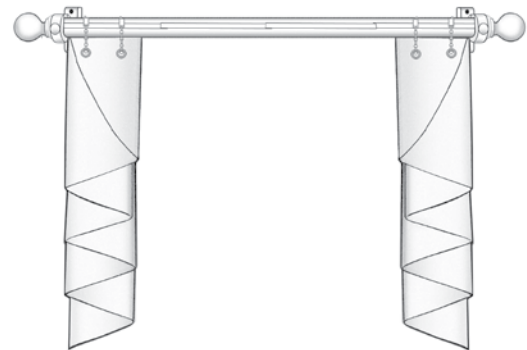

Step 5: Place the Swags on the Pole

Single Swag

Attach the swag to the pole by joining the VELCRO strips.

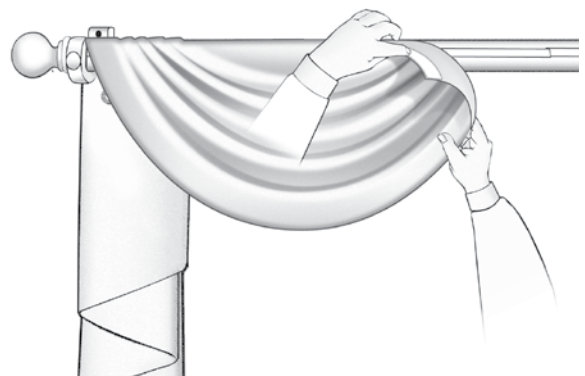

Multiple Swags

Reserve the swag that has both VELCRO strips on the underside for the far right. Attach the swags to the VELCRO strips, beginning at the left end.

Step 6: Dress the Swags and Cascades

Arrange the folds of the swags and cascades and steam out any wrinkles as needed.

Scarf Valance

Hardware

- 2 sconces
- 2 sconce brackets
- Screws

Step 1: Mount the Scarf Holder (Sconce)

Mark the top center point of each sconce on the wall, making sure the markings are level. Mark the mounting screw positions below each center point. (Mounting screws for Madison wood sconces are positioned $1\frac{1}{2}$ " and $2\frac{3}{4}$ " below the top center point.)

Drill $\frac{1}{16}$ " pilot holes and set the mounting screws, leaving about a $\frac{5}{16}$ " projection. Place each sconce on the screws and allow it to drop into place.

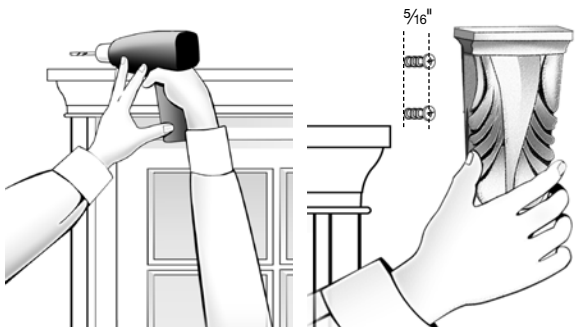
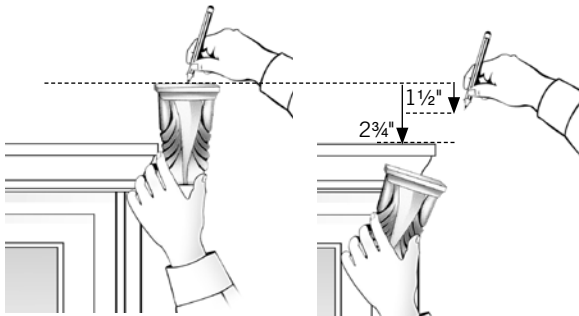

Step 2: Hang the Scarf

The scarf is shipped folded and secured with paper bands. Leave the paper bands on the scarf until it is necessary to remove them. Matching fabric tie bands are provided to hold the valance folds together inside the sconces.

Orient the scarf with the long side on top and the edge of the fabric toward the wall. Guide each end through its sconce, removing the paper band when necessary.

When the scarf is in place in the sconces, tie a fabric tie band around it at each sconce. Then guide the fabric into the sconce so the tie is hidden.



Adjust the position of the scarf so that the drop is equal on both sides and the fabric between the sconces is straight.

Conditional Step:

If you are working with a very light fabric, you may need to secure the scarf in position by fastening the ties to the wall. Fasten a hook (not included) to the wall at the inside edge of each sconce where it will be hidden from view. Loop or tie the tie band onto the hook.

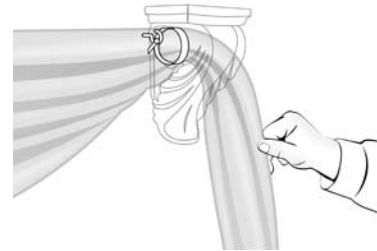

Dress the Scarf

Grasp the bottom fold of the scarf mid way between the sconces and gently pull down until it is positioned at the desired height. Dress the remaining folds so they drape smoothly.

Caring for Your Valance

These valances will provide you with years of beauty and pleasure with minimal care and cleaning. To care for your valance:

- Vacuum using a brush or dust head attachment.
- Dust lightly using a soft, clean cloth.
- Dry clean your valance if it needs a more thorough cleaning.
- Never immerse your valance in water or liquids of any kind.